

Features

- Range of backsets available
- Locks accept standard 1⁵/₃₂" mortice key or thumbturn cylinder
- Faceplate finish SAA
- Stainless steel laminated lockbolts

Functionality

Deadlocks are available in both bar and hookbolt versions. The locks provide security deadlocking for a variety of aluminium doors including swinging and sliding applications.

The hookbolt is constructed from stainless steel and is a 5 ply laminated construction, with the centre core case hardened, complete with hardened roll pin to resist hacksaw attack.

All locks are designed to accept standard round mortice cylinders or thumbturns.



52185 Lock Type

Code	Description	For use with	Finish
5218501	Narrow stile long throw barbolt deadlock to suit mortice cylinder 7/8" backset		N/A
5218502	Narrow stile long throw barbolt deadlock to suit mortice cylinder 31/32" backset		N/A
5218503	Narrow stile long throw barbolt deadlock to suit mortice cylinder 1 1/8" backset		N/A
5218504	Narrow stile long throw barbolt deadlock to suit mortice cylinder 1 1/2" backset		N/A
52FP1851	Flat faceplate - width 25mm	1850	SAA
52FP1852	Radius faceplate - width 25mm	1850	SAA
52FP1853	Radius faceplate with weather strip - width 25mm	1850	SAA

For details of the faceplate variants available, see page 13.

Imperial Backset	Metric Equivalent	Dimension A
7/8"	22.2mm	39.9mm
31/32"	24.6mm	41.4mm
1 1/8"	28.6mm	45.2mm
1 1/2"	38.1mm	57.1mm

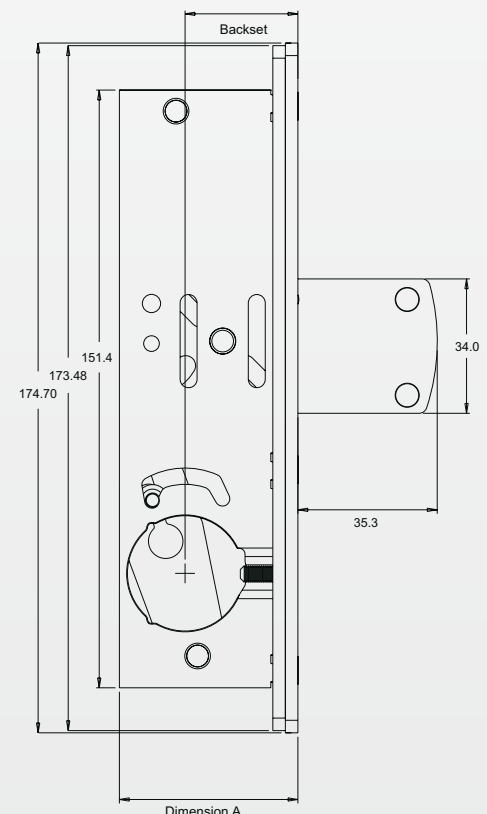

Alpro offer a range of faceplates for our Deadlocks and Deadlatches.

Features

- These are available in flat, radius and weather strip versions.
- Faceplate finish – SAA

Code	Description	
For use with Europrofile Deadlocks - Type 52220 page 10		
52FP221	Flat faceplate – bar bolt	W 25 x H 197mm
52FP222	Flat faceplate – hook lock only	W 25 x H 197mm
52FP225	Radius faceplate – hook lock only	W 25 x H 197mm
52FP228	Radius faceplate with weather strip	W 25 x H 197mm

Code	Description	
For use with Round Mortice Cylinder Deadlocks - Type 52185 page 9		
52FP1851	Flat faceplate	W 25 x H 174mm
52FP1852	Radius faceplate	W 25 x H 174mm
52FP1853	Radius faceplate with weather strip	W 25 x H 174mm

52FP221 & 52FP222 (dimensions red)

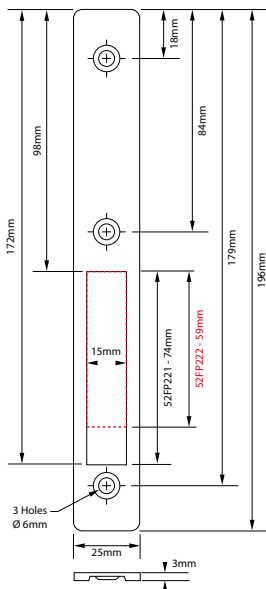

52FP225

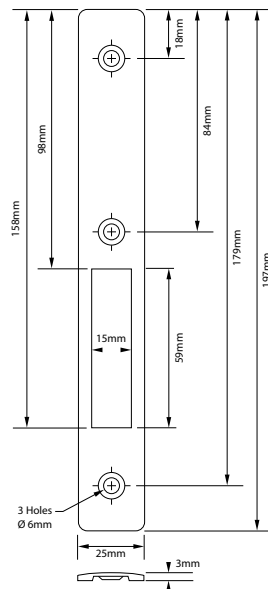

52FP228

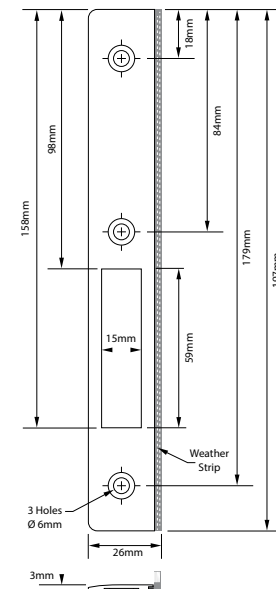

52FP1851

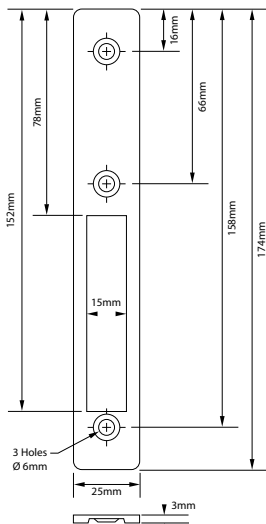

52FP1852

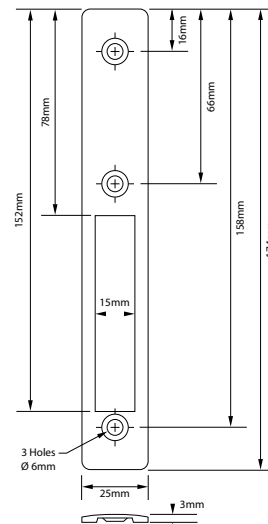

52FP1853

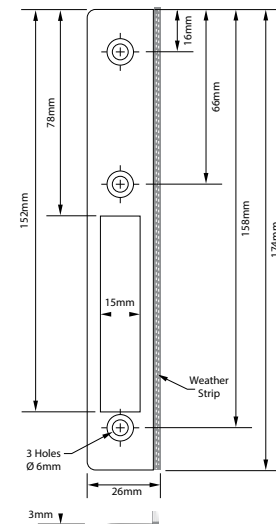

locks

Faceplates

Code	Description
For use with Round Mortice Cylinder Deadlocks - Type 52182 page 8	
52FP1821	Flat faceplate W 25 x H 174mm
52FP1822	Radius faceplate W 25 x H 174mm
52FP1823	Radius faceplate with weather strip W 25 x H 174mm

Code	Description
For use with Europrofile Cylinder Deadlatches - Type 524510 page 11 & Type 524570 page 12	
52FP4511	Flat faceplate W 25 x H 175mm
52FP4512	Radius faceplate W 25 x H 175mm
52FP4513	Radius faceplate with weather strip W 25 x H 175mm

52FP1821

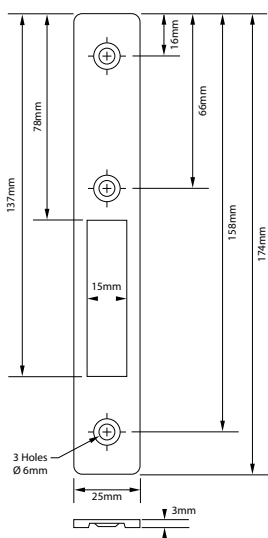

52FP1822

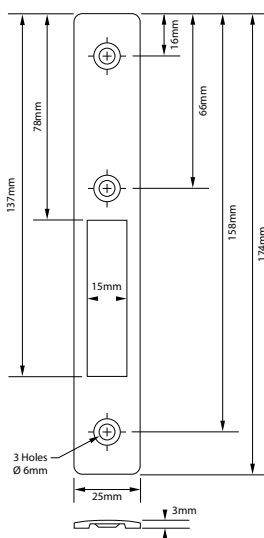

52FP1823

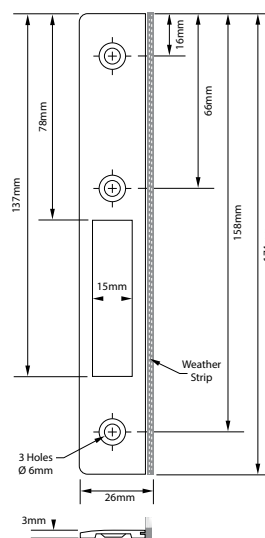

52FP4511

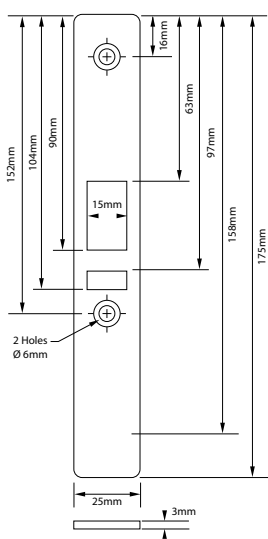

52FP4512

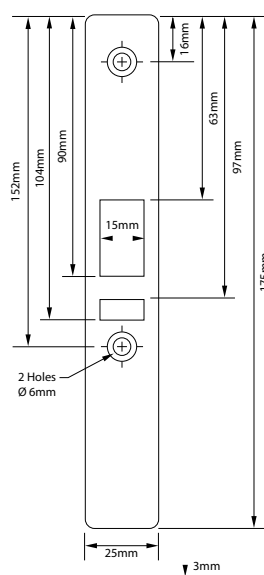

52FP4513

